

Heavy Industrial



Solving Your Motion Control Challenges With Ingenuity

Evolution Motion Solutions is a leading engineering partner, systems integrator, and value-added distributor of advanced hydraulic, electromechanical, and pneumatic technologies.

For over 80 years, our innovative solutions have been built on a foundation of technical excellence and industry-leading components designed for factory automation, heavy industrial, and mobile/off-highway applications.

We may not manufacture our customers' systems and machines, but we do help them run more efficiently and reliably by optimizing production time and enhancing performance.



Heavy Industrial

Evolution Motion Solutions Heavy Industrial encompasses everything required to design, build, maintain, and optimize hydraulic systems. We provide a wide array of value-added services that include locally-performed certified repairs and industry-leading hands-on-training. With over 80 years of industry experience and technical expertise in hydraulics, electronics, drives, and controls, we inspire customers to do more than they ever thought possible.



Factory Automation

Evolution Motion Solutions provides integrated engineering solutions, expertise, and resources for automation, controls, pneumatic, electrical, hydraulic, sensing, joining, dispensing, and lubrication applications. With over 80 years of unparalleled experience in industrial product application, Evolution is your expert engineering partner for system and subsystem integration and value-added distribution, from initial concept and product to development and support.



Mobile/Off-Highway

Evolution Motion Solutions provides technical expertise and resources to supply integrated solutions for actuation, optimization, propulsion, and electrification technologies for mobile/off-highway applications. With unparalleled experience in mobile product application and value-added distribution, Evolution is your trusted engineering partner for system and subsystem integration, conceptualization, production, installation, and support.



LEARN



THINK



PLAN



INTEGRATE



DESIGN



SUPPORT



SOURCE



TEST



BUILD

Complete Life-Cycle Support

One Team. Infinite Solutions.

Driven by a passion for innovative technology and conquering challenges, we develop solutions that keep our customers moving toward the future. From concept to completion, we provide exceptional customer service deeply rooted in our Commitment to Excellence.

- Solutions Based Engineering
- Design Engineering for Hydraulics, Pneumatics, Lubrication, & Mechanical Solutions
- Machine Control Design Experience
- Hardware & Software Design
- Concept & Process Engineering
- System Integration Solutions
- Subsystem Efficiency Solutions
- Modification of Machines to U.S. Standards & Specifications
- Quality Assurance According to ISO 9001 & AS 9100
- Designs & Capabilities According to U.S. & European Standards NFPA, UL, CE

Elements of Success

From our beginnings as a trusted resource for premier components, we have evolved into Evolution Motion Solutions, an engineering partner, systems integrator, and value-added distributor (ESV).

As the world's first ESV, we provide our customers with highly engineered solutions for motion control tasks. By leveraging our group members' diverse industry experience and product knowledge, we engineer technically superior solutions with sustainable value.



We function as an extension of your engineering team. By delivering tailored solutions that address your specific needs, whether product sizing, concept engineering, or training, we ensure success and innovation at every step.

- Factory Trained Service Technicians
- Dedicated Product Management
- Maximum Stocking Levels
- Integrated Systems
- Application Engineering
- Custom Products & Solutions
- 3D Modeling & FED Analysis
- Advanced Product Training
- Product & Machine Expertise
- Research & Development
- Product Launch Support
- Safety Reviews
- Prototyping



Our engineering expertise extends to integrating new and legacy systems, optimizing them for improved performance, reliability, and longevity by delivering application assistance, product support, and turnkey solutions.

- Service Technicians
- Application Assistance
- Committed Inventory Program
- Configured Assemblies
- Product Sizing & Selection
- Integrated Products
- Concept Engineering
- Training



We go beyond traditional distribution by offering value-added services such as 24/7 support, product kitting, and inventory management. We provide high-quality components and solutions that meet your needs—every time.

- 24/7 Support
- Customer Service
- Inventory Management
- Configured Assemblies
- Product Kitting
- Product Support

Fluid Power

Evolution Motion Solutions extensive range of hydraulic products provides the fluid power necessary to unlock the potential of hydraulics in your industrial applications. From hydraulic cylinders and pumps to valves and motors, we offer top-quality components for any fluid power need.

Pumps

Motors

Valves

Filters

Cylinders

Thermal Management

Accumulators

Hydraulic Power Units (HPUs)

Fluid Diagnostics

Special Components & Accessories



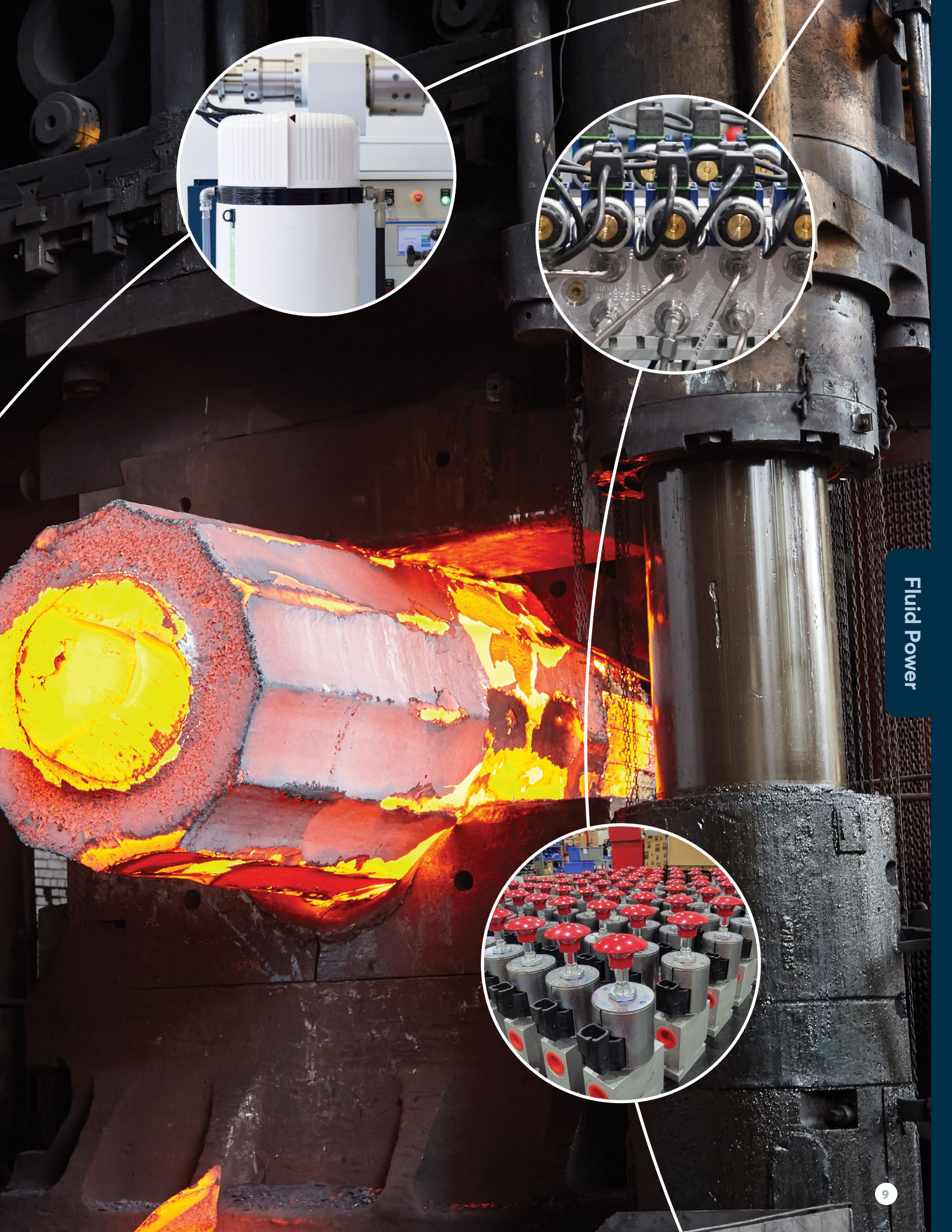

Fluid Power

Electronics, Drives & Controls Products

Evolution Motion Solutions employs a flexible design concept for its controls systems. Designs range from small, compact, all-in-one drive systems to large modular systems to panel-free technology. These products provide exceptional diagnostic capabilities, including Industry 4.0 solutions. Our safety product offering is the broadest in the industry and provides flexible software solutions.

Variable-Frequency Drives

Panel Builds

Machine Safety

Automatic Identification

Custom Cable Configurations

Measurement Technology

PLCs & HMIs

Power Supply Distribution

Sensing Technology

Servo Drives & Controls

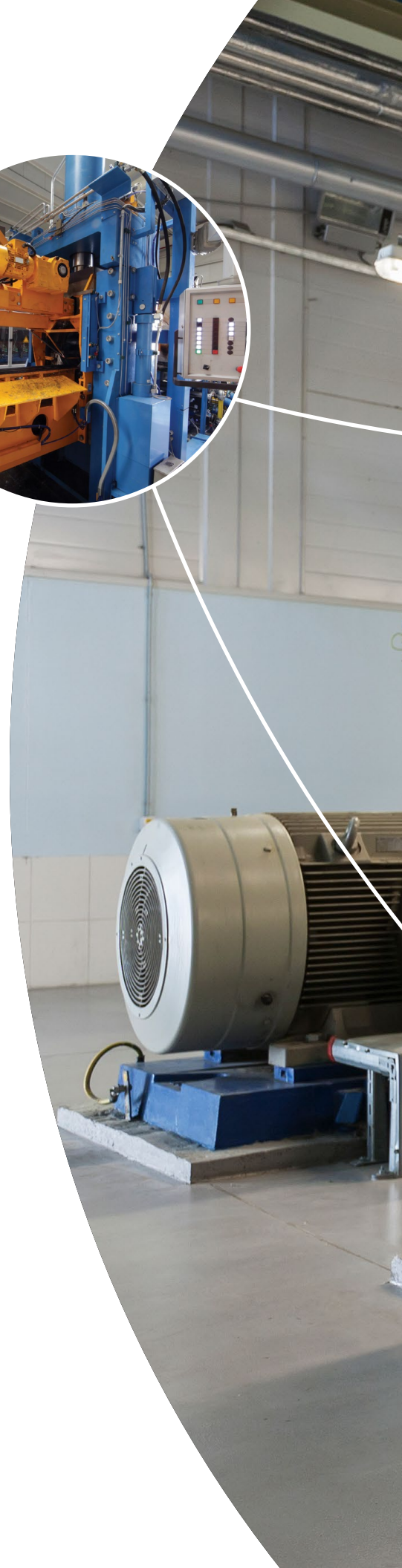



Controls

Custom Systems

Evolution Motion Solutions manufactures custom systems for your specific applications. Our mission is to provide competitive value-added solutions for our customers - we'll put your world in motion.

Custom Solutions

Engineering & Design

Custom HPUs

High Pressure Systems

Custom Test Systems

Electrical Control Panels

Automation Control Systems

Custom Assemblies

Total Quality Leadership

Testing & Inspections

Quality Standards

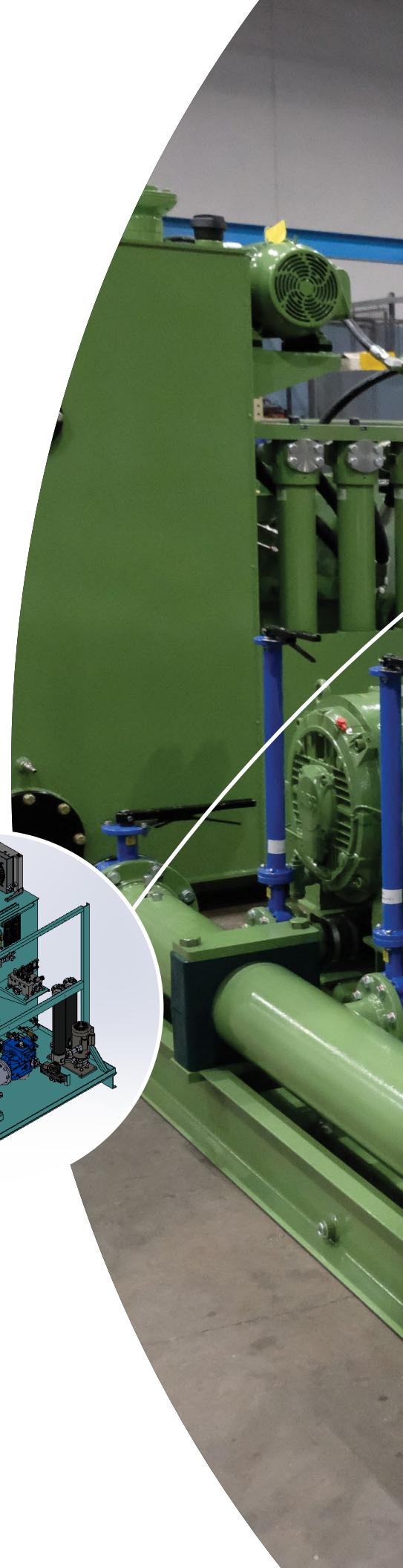
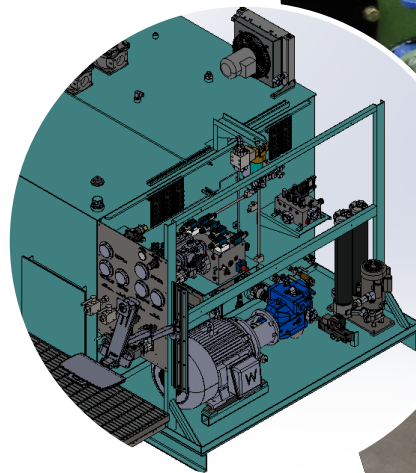



Custom Systems

Hydraulic Hands-On Training

Evolution Motion Solutions is a nationally recognized leader in fluid power training, with over 80 years of training experience featuring our own fluid power textbooks and our custom-built trainers. Our many years of training experience and recognized textbooks uniquely qualify us to host these in-depth, 3-day and 4-day hands-on training seminars and in-plant custom courses that cover the most up-to-date topics, technologies, and techniques. These hands-on training courses teach and guide attendees to quickly identify and troubleshoot hydraulic equipment, skills that can significantly reduce system downtime.

Basic Hydraulic Principles

Hydraulic Pressure Control

Hydraulic Cylinder Principles

Filtration Basics

Troubleshooting Principles

Load Control

Directional Control of Cylinders and Motors

Pump Cavitation Basics

Sequence Valves

Hydraulic Motor Principles

Pressure Compensated Pump Basics

Pump Unloading

Over 15 Hands-On Exercises

Reading and Understanding Schematic Symbols



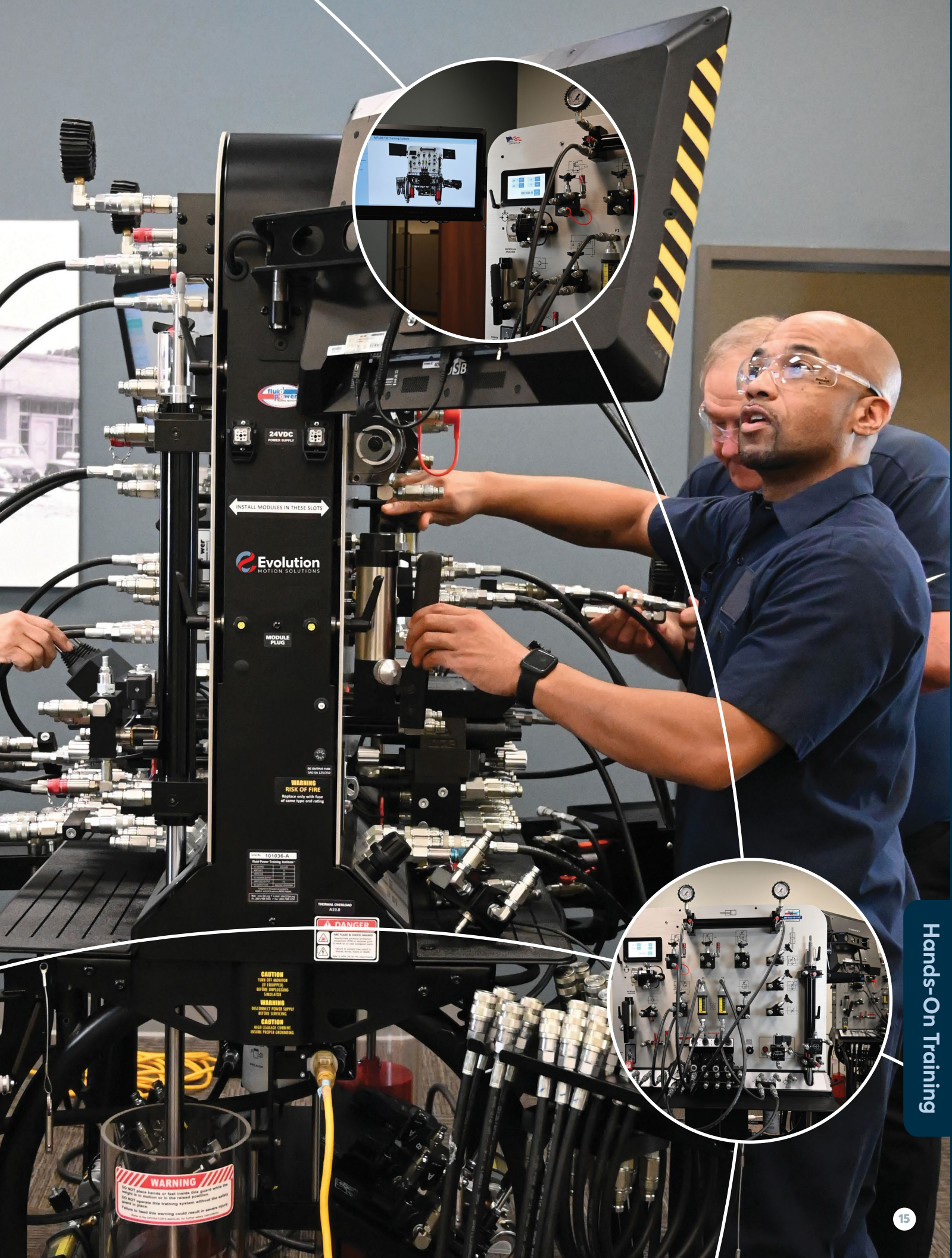

INSTALL MODULES IN THESE SLOTS



MODULE PLUG

WARNING
RISK OF FIRE
Replace only with fuse of same type and rating

101036-A
Pneumatically Operated
Fluid Power Training System

⚠ DANGER
High Pressure Hydraulic System
Pressure Release Valve
Warning: Do not touch the pressure release valve until the pressure has been released. Failure to do so could result in injury or death.

CAUTION
TOP OF MACHINE IS HOT
IF EQUIPPED WITH HYDRAULIC TRAINING SYSTEM
WARNING
DISCONNECT POWER SUPPLY BEFORE SERVICING
CAUTION
HOLD BRACKETS FIRM DURING PEOPLE CROSSING

WARNING
DO NOT place hands or feet inside the power while the system is in motion or in the reared position.
DO NOT operate this training system without the safety fence in place.
Failure to heed this warning could result in severe injury or death.

Hands-On Training

Service and Repairs

Evolution Motion Solutions provides certified hydraulic pump and motor repairs performed locally by highly trained, certified repair technicians. With AS 9100 and ISO 9001 certifications, the company adheres to the highest quality management standards to ensure precision and reliability in every repair. Utilizing advanced testing equipment, each component is thoroughly inspected, tested, and backed by a comprehensive warranty, guaranteeing it meets or exceeds customer expectations. By offering local repair services with a warranty, Evolution ensures faster turnaround times, reduced downtime, and long-term, efficient performance for customer operations.

Conversions

Emergency Repairs

Exchange Programs

Inspection & Reporting

Remanufactured Products

Reset Components to Factory Specs



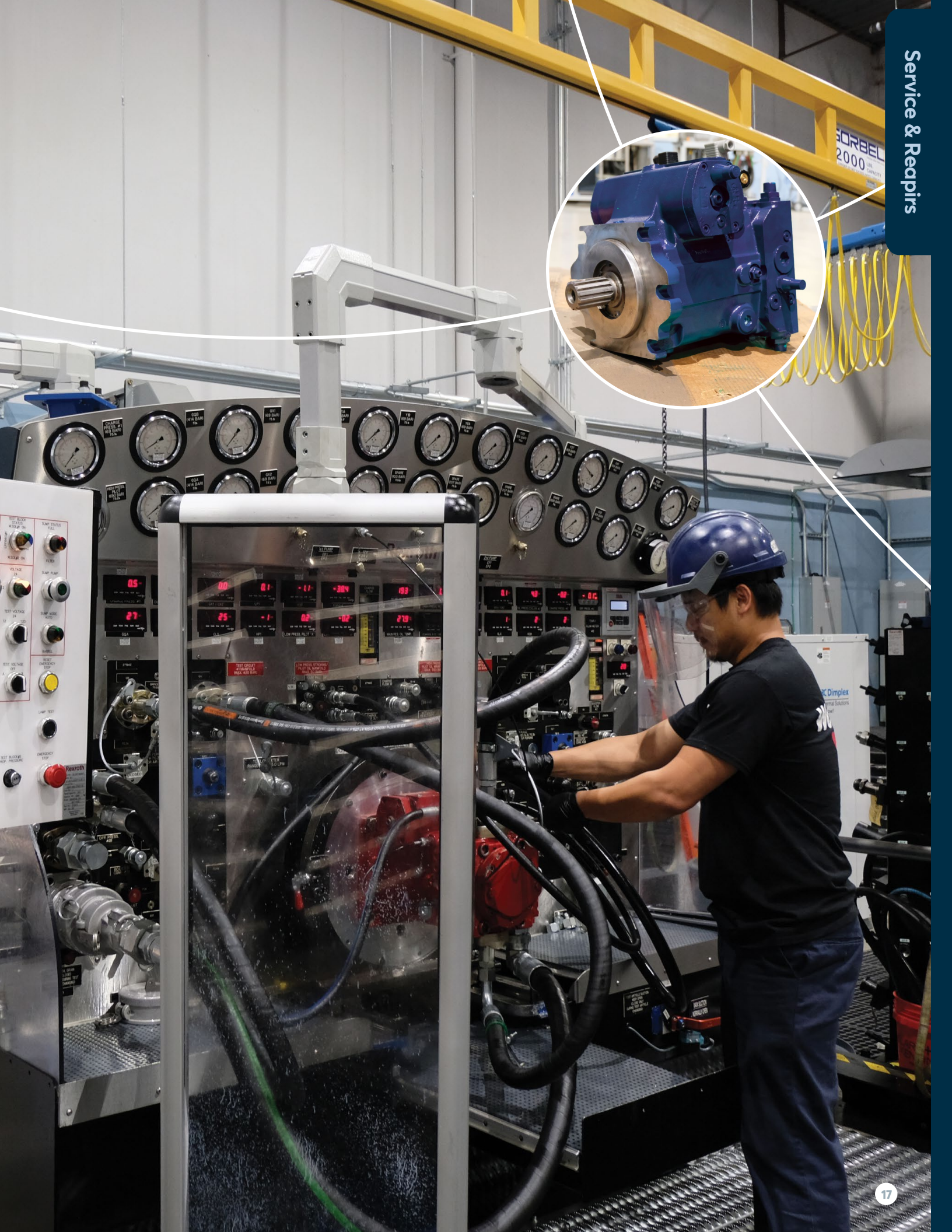
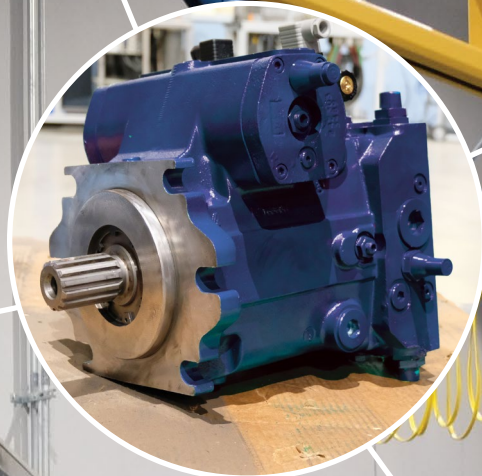

Value-Added Services

Evolution Motion Solution's comprehensive range of value-added services can increase your productivity and eliminate touchpoints with other service providers. We are your one-stop shop for all things motion control.

Product Modifications

Product Kitting

Private Labeling

Special Packaging

Evolution Inventory Management

24/7 Support

Machine Start-Up & Commissioning

Strategic Sourcing

Factory Trained Repair Technicians

Customer Service

Hands-On Training

Aftermarket Programs

Shipping/Freight Consolidation

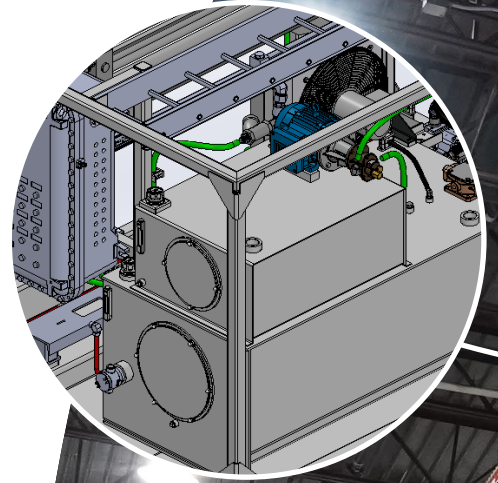



Fluid Power

- Pumps**
- Motors**
- Valves**
- Filters**
- Cylinders**
- Thermal Management**
- Accumulators**
- Hydraulic Power Units (HPUs)**
- Fluid Diagnostics**
- Special Components & Accessoriess**

Controls

- Variable-Frequency Drives**
- Panel Builds**
- Machine Safety**
- Automatic Identification**
- Custom Cable Configurations**
- Measurement Technology**
- PLCs & HMIs**
- Power Supply Distribution**
- Sensing Technology**
- Servo Drives & Controls**

Custom Systems

- Custom Solutions**
- Engineering & Design**
- Custom HPUs**
- High-Pressure Systems**
- Custom Test Systems**
- Electrical Control Panels**
- Automation Control Systems**
- Custom Assemblies**
- Total Quality Leadership**
- Testing & Inspections**
- Quality Standards**

Hand-On Training

- Basic Hydraulic Principles**
- Hydraulic Pressure Control**
- Hydraulic Cylinder Principles**
- Filtration Basics**
- Troubleshooting Principles**
- Load Control**
- Directional Control of Cylinders and Motors**
- Pump Cavitation Basics**
- Sequence Valves**
- Hydraulic Motor Principles**
- Pressure Compensated Pump Basics**
- Pump Unloading**
- Reading and Understanding**
- Over 15 Hands-On Exercise**
- Schematic Symbols**

Service & Repair

- Conversions**
- Emergency Repairs**
- Exchange Programs**
- Inspection & Reporting**
- Remanufactured Products**
- Reset Components to Factory Specs**

Value-Added Services

- Product Modifications**
- Product Kitting**
- Private Labeling**
- Special Packaging**
- Evolution Inventory Management**
- 24/7 Support**
- Machine Start-Up & Commissioning**
- Strategic Sourcing**
- Factory Trained Repair Technicians**
- Customer Service**
- Hands-On Training**
- Aftermarket Programs**
- Shipping/Freight Consolidation**

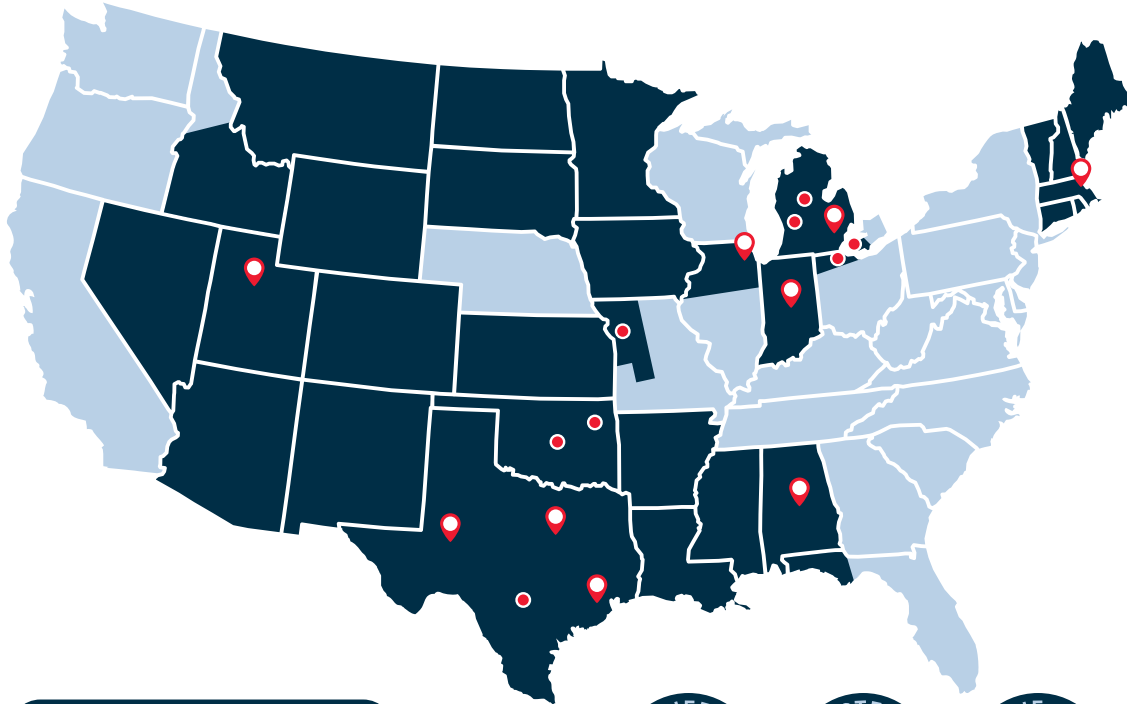

 **Warehouse & Sales**
 **Sales Offices**



Head Office

13835 Senlac Dr. Farmers Branch, TX 75234 (800) 569-9800

Local Offices

ALABAMA

511 Mineral Trace,
Suite 100
Hoover, AL 35244
(205) 417-4177

ILLINOIS

340 Windy Point Dr.
Glendale Heights, IL 60139
(630) 858-4600

INDIANA

9589 E. 153rd Street
Noblesville, IN 46060
(317) 849-7007

MASSACHUSETTS

90 Research Dr.
Wilmington, MA 01887
(248) 373-1600

MICHIGAN

3333 Bald Mountain Rd
Auburn Hills, MI 48326
(248) 373-1600

408 Broadway Ave NW, Suite C
Grand Rapids, MI 49504
(616) 583-9390

7131 W. Drew Rd
Weidman, MI 48893
(866) 644-8622

MISSOURI

171 English Landing Dr.
Suite 230
Parkville, MO 64162
(800) 569-9800

OHIO

1705 Indian Wood Circle,
Suite 104,
Maumee, OH 43537
(419) 365-3111

OKLAHOMA

5114 S. 95th East Ave.
Tulsa, OK 74145
(800) 569-9800

3445 West Memorial Rd,
Suite J
Oklahoma City, OK 73134
(800) 569-9800

TEXAS

8707 Fallbrook Dr.
Houston, TX 77064
(800) 569-9807

1803 W. County Rd 114
Midland, TX 79706
(800) 569-9800

2090 N Interstate
35 Frontage Rd
Suite 4101
New Braunfels, TX 78130
(800) 569-9800

UTAH

5575 West 1730 S,
Suite 102
Salt Lake City, UT 84104
(801) 566-4333

CANADA

2775 Kew Dr.
Windsor, Ontario
Canada N8T3B7
(519) 944-3877